

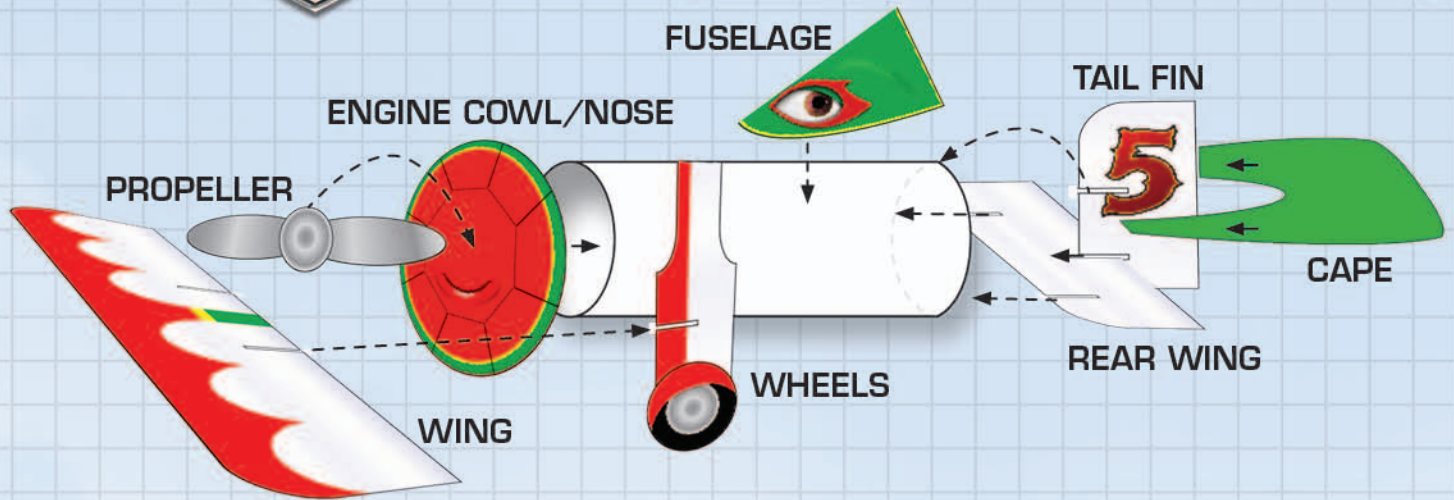

EL CHUPACABRA TUBE PLANE



YOU WILL NEED:

Empty Toilet Paper Roll,
Glue, Brass Fastener,
Scissors, Thick Paper
or Card Stock.

DIRECTIONS:

Have an adult help you with this activity!

- 1) Print the attached pages on thick paper or card stock.
- 2) Have an adult help you cut out each piece from the template. Then carefully cut small slits where indicated. Set aside.
- 3) Wrap the toilet paper roll with the wheels making sure the connection joints are facing forward. Attach to the wings from the bottom of the toilet paper roll. Secure with glue.
- 4) Place the propeller in the center of the engine cowl/nose and secure with a brass fastener or glue.
- 5) Take the engine cowl/nose and place it on the (front side) open end of the toilet paper roll. Fold around the toilet paper roll and secure with glue.
- 6) Have an adult help you cut three slits on the back side of the toilet paper roll.
- 7) Slide the rear wing into the slits on the back side of the toilet paper roll. Secure with glue.
- 8) Slide the tail wing into the slit of the back side of the rear wing and to the slit at the top of the toilet paper roll. Secure with glue.
- 9) Slide the cape around the wing and secure towards the center-top of the toilet paper roll with glue.
- 10) Bend the fuselage to snugly fit the top of the toilet paper roll, covering the ends of the cape.



ON BLU-RAY™ COMBO PACK
& DIGITAL HD **NOVEMBER 19**





Have an adult help you with this activity.

CAPE

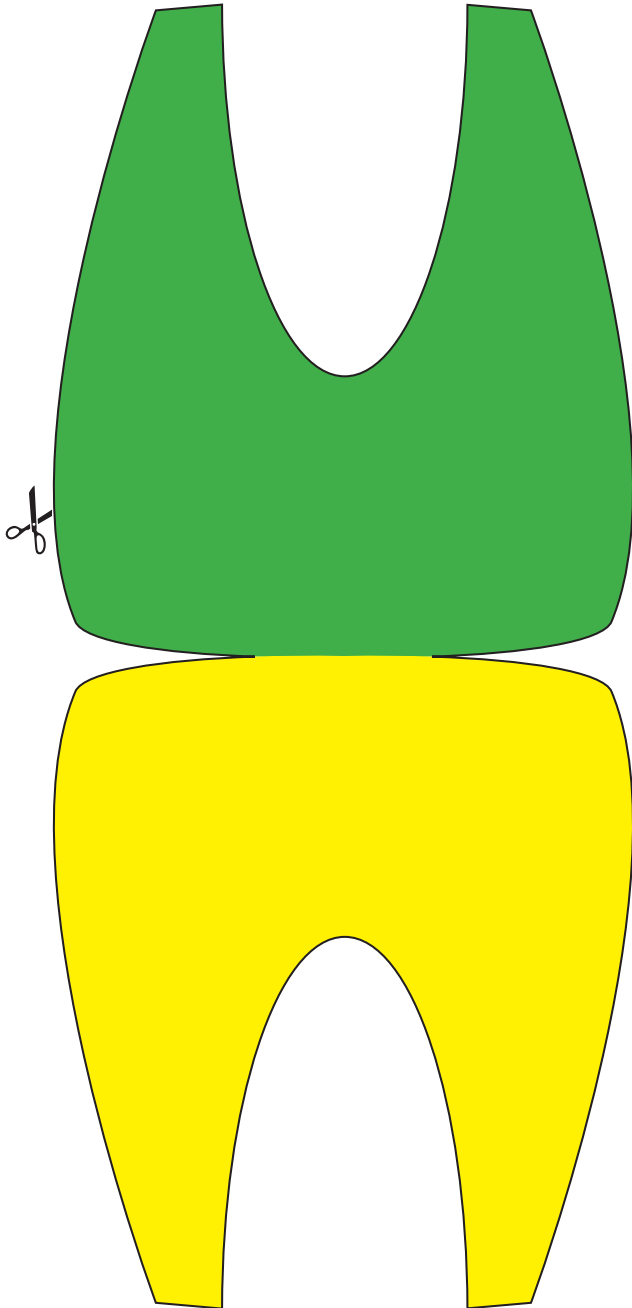

ENGINE COWL/NOSE

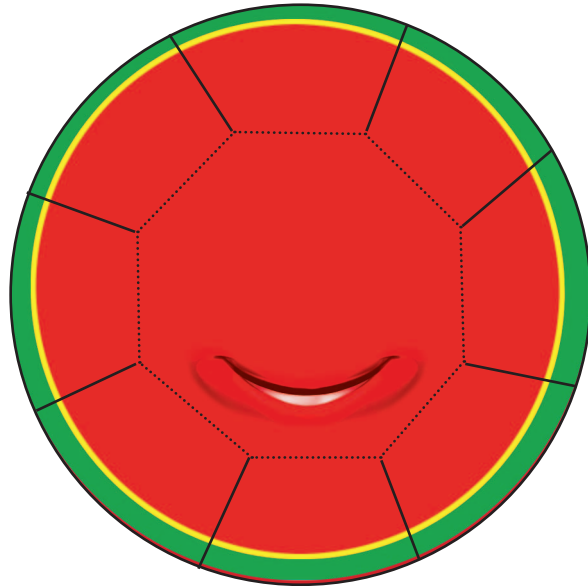

FUSELAGE

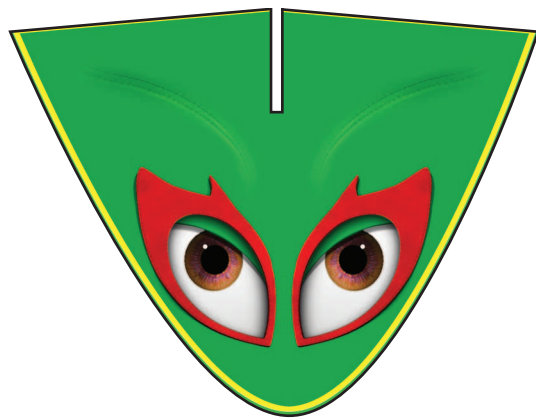

PROPELLER

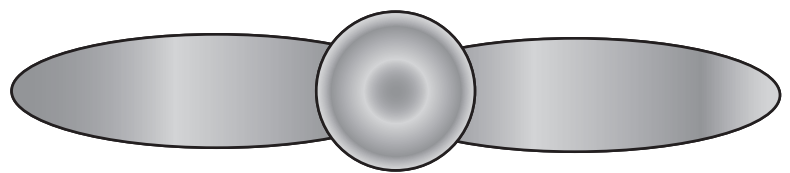

WHEELS

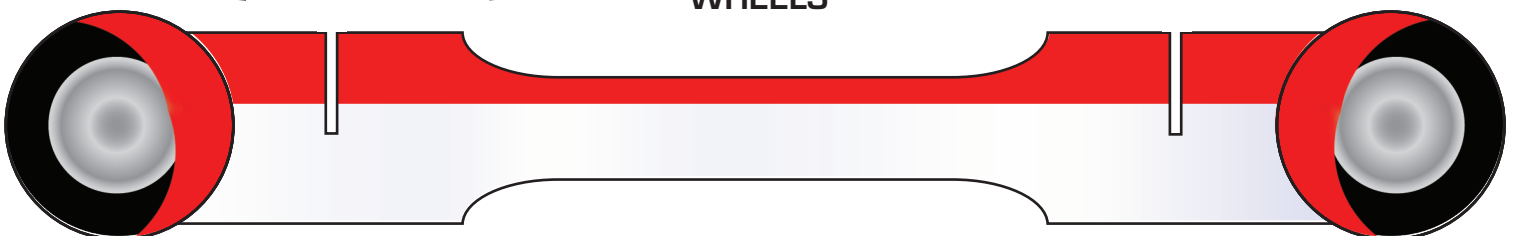



Have an adult help you with this activity.

REAR WING

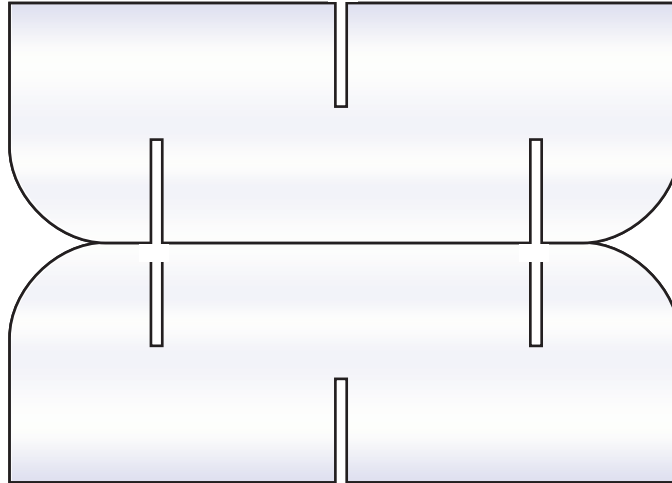

TAIL FIN



WING

